DESICCANT DEHUMIDIFIER

USER MANUAL



DISPOSAL



The appliance must not be disposed of with household waste, but taken to an authorised waste separation and recycling centre.

Please read instructions before use
Keep for future reference

Visit [ecoair.org](https://www.ecoair.org) to register your product
or terms and conditions

WELCOME

Thank you and congratulations for choosing an EcoAir dehumidifier to help you improve the air quality within your environment. Inside you will find many helpful tips on how to use and maintain your dehumidifier efficiently. Just a little preventative care can save you money and prolong the life of your dehumidifier.

The purpose of the dehumidifier is to remove the excess moisture in the air by detecting the humidity level in the room. By keeping humidity within recommended levels, a dehumidifier combats household damp, mould and mildew. Dehumidifiers can help to reduce the symptoms of asthma, allergies, and other respiratory health conditions. They can also be used to help dry laundry quicker and control moisture-based damage (such as the aftermath of flooding, leaks or rising damp) to valuable belongings and furniture.

HUMIDITY GUIDE

There will always be water vapour in the air. The water vapour (or commonly known as moisture) in the air is measured in Relative Humidity (RH) %. RH is the ratio of the actual amount of water vapour in the air to the amount it could hold when saturated expressed as a percentage. Too much or too little moisture in our homes can be unhealthy and uncomfortable. The optimum humidity level is between 40% and 60% (RH) where we feel most comfortable.

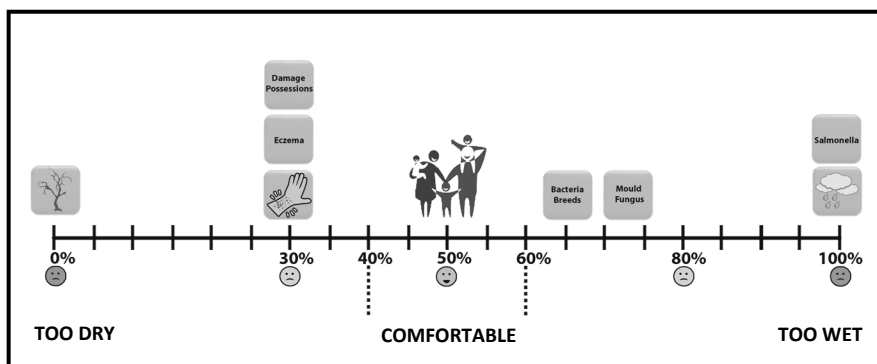

Low humidity

Low humidity indoors causes excess drying which can trigger skin irritations such as eczema, chapped skin and dry nose. It can also damage possessions, such as wooden furniture, musical instruments and artwork by drying it out too much.

High humidity

High humidity indoors causes damp and condensation. The damp left by condensation can damage plaster, wall paper, furniture, vehicles, timber windows, doors and clothes. It can be harmful to our health when bacteria thrives, causing mould and fungus.

Maintaining safe levels of humidity

It is important to maintain a consistent humidity range to preserve furniture, paintings, door and window frames. High humidity causes swelling, corrosion, softening of glues and paint. Low humidity causes shrinking, cracking, warping of wood surfaces and gaps in joints, doors and windows. Frequent changes in humidity levels can accelerate damages to property and belongings.

Condensation

The warmer the air, the more moisture the air can hold than colder air. So, when the air inside the house becomes colder, the moisture contents in the air becomes saturated, and gets heavier resulting in moisture concentration on the coldest parts of the house particularly on the windows, bathroom mirrors and walls. This is condensation, caused by a sudden increase in humidity, cooking, showers, drying clothes, inadequate ventilation and poor thermal insulation.

Condensation does not disappear instantly even with the dehumidifier on. Where excessive condensation appears for example, on your windows, you may want to open your windows to expel the excess humidity for several minutes. It will take a while for the condensation to generally increase the humidity in the room. Once the humidity level in the room around the dehumidifier is increased above the level you have set on the dehumidifier, it will then begin the dehumidification process.

INDEX

Important Safety Instructions	1
The Appliance and Accessories	2
Important Safeguards	3
Installation	4
Setup Continuous Drainage	5
Control Panel	6
Operation	7 - 8
Emptying the Water Tank	9
Cleaning, Maintenance and Storing the appliance	10
Troubleshooting	11

IMPORTANT SAFETY INSTRUCTIONS

WARNING!



This dehumidifier is intended for use in domestic households and similar working and residential environments and is not intended for outdoor use. It must be used only as a domestic appliance. EcoAir cannot be held liable for damage resulting from incorrect or improper use or operation

- Do not alter or modify the appliance's characteristics in any way. Should repairs be necessary, contact EcoAir's Authorised Service Centre. Self-servicing or unauthorised servicing can be dangerous.
- The appliance must be installed in accordance with the relevant national legislation.
- The appliance is not intended for use by persons (including children) with reduced physical, sensory or mental capabilities, or lack of experience and knowledge, unless they have been given supervision or instruction concerning the use of the appliance by a person responsible for their safety.
- Children and pets should be supervised to ensure they do not play with the appliance.
- Do not use the appliance if the power cable, cord is damaged. It must be replaced by an EcoAir's Authorised Service Centre.
- The appliance must always be placed in an upright position on an even level surface to avoid any damage, during use or transportation and when put into storage.
- The appliance must be plugged into a grounded 3-prong outlet and ensure that the voltage matches the rated specifications. If in doubt, check with a qualified technician.
- Do not use with extension cables or multi sockets. Do not pull or place strain on the power cord when moving appliance.
- Always unplug the appliance before cleaning or maintenance or when not in use.
- The appliance must not be placed or used where the atmosphere may contain combustible gasses, oil or sulphur or solvent, or near heat sources (such as heaters or in server rooms) or excessive dust.
- Do not place or rest any objects on the appliance and do not cover while in use. Always observe the minimum room size for storing and operating the appliance.
- Allow a minimum of 40 cm clearance around the appliance. Do not place any objects in close proximity to the appliance.
- Filter must be cleaned every 2 weeks to avoid dust building up internally causing overheating and malfunction.
- To protect against electric shocks, do not immerse or spray the appliance or any of its parts in water.
- Ensure the air inlet and outlet are not blocked or covered when in use.
- Do not insert fingers or any objects into the air inlet or outlet openings.
- Do not operate or store the appliance under direct sunlight.
- Always switch off the power before unplugging from the socket.
- Do not leave the appliance running or plugged in over a long period of time unattended. Leaving unattended electrical appliances running is unsafe.
- Always make sure your hands are dry when operating the appliance.
- Only operate the appliance within the specified operating temperature range.
- Do not run power cord under carpeting, or cover with rugs or runners. Arrange the cord away from areas where it may become a trip hazard.
- This appliance must not be used outdoor or wet areas such as bathrooms.
- Do not use the Laundry Mode function over a long period of time or unattended. When drying laundry, do not place laundry on the appliance. Always ensure the laundry is placed a safe distance from the dehumidifier at least 40cm.
- Always clean the filter and cover the dehumidifier with a dust sheet when storing the dehumidifier.

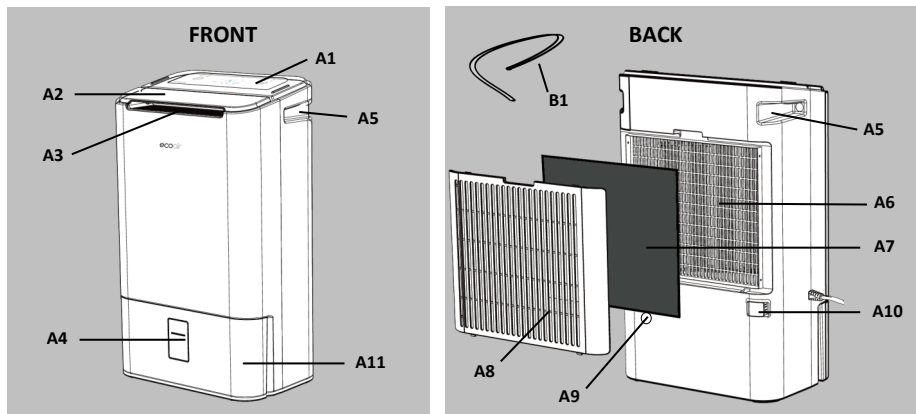
THE APPLIANCE & ACCESSORIES



Accessories List

	
B1	B2

DESCRIPTION	
Key	Description
A1	Control Panel
A2	Louvre
A3	Air Outlet
A4	Water Level Indicator
A5	Grab Handle
A6	Air Inlet
A7	Active Charcoal Filter (Optional)
A8	Silver Nano Filter
A9	Continuous Drain Knockout
A10	Cable Tidy
A11	Water Tank
Key	Description
B1	Continuous Drainage Hose
B2	User Manual

IMPORTANT SAFEGUARDS

WHERE TO POSITION YOUR DEHUMIDIFIER?

Ensure the unit is a safe distance away from a wall or furniture and away from direct sunlight.

TIP: Position the dehumidifier in the dampest room or somewhere central like a landing or a hallway. As long as the internal doors are open the excess moisture from all of the rooms in the house will migrate naturally towards the dehumidifier and be processed.

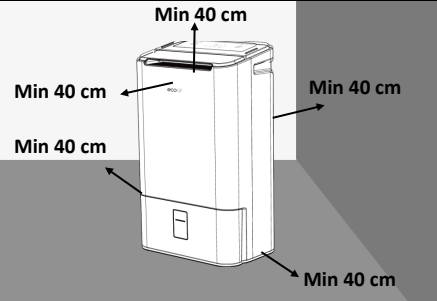

DO NOT PLACE OBJECTS ON OR OVER THE APPLIANCE

Ensure the air inlet (A6) and air outlet (A3) are not obstructed. Obstruction will cause overheating and malfunction.

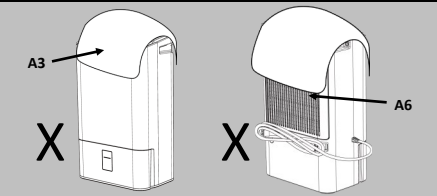

DRYING YOUR LAUNDRY

Never place wet laundry over the appliance. Dry the laundry on a rack with a minimum distance of 40 cm.

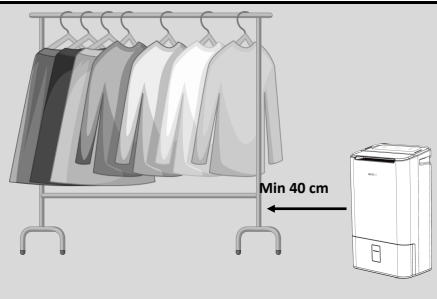

ROOM SIZE



- Never use in small confined area. (Broom cupboard, boiler room, unventilated rooms, in close proximity to a heat source such as heater, tumble dryer, cooker).

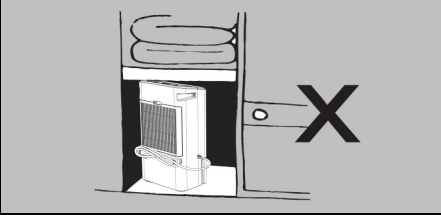

DO NOT SPLASH

- Do not wash the appliance or immerse in water
- Do not allow water to drip on to the appliance

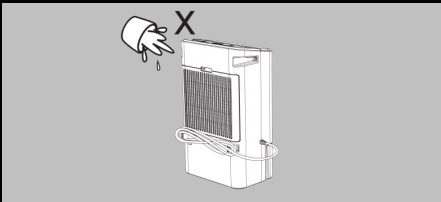

PLACE ON EVEN LEVEL FLOOR

- Always operate appliance on an even level floor to avoid leakage
- If appliance is on carpet, ensure the appliance is stable and level

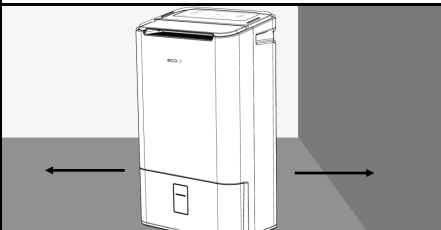

IMPORTANT

- Do not move the appliance or remove the water tank when the dehumidifier is running. It may cause damage, electric shock, water leak or spills.
- After turning the dehumidifier off, the fan will continue to run for 2 minutes. This is to help to cool and protect the internal components. During these 2 minutes, do not remove the power plug from the power socket, wait for the fan to stop.
- Dusty, building sites or an industrial environment where particles can clog up the filter or internal components.

INSTALLATION

PLEASE READ IMPORTANT SAFEGUARDS BEFORE INSTALLATION

FIND A SUITABLE POSITION

- Position the dehumidifier in the dampest room or somewhere central like a landing or a hallway. As long as the internal doors are open, the excess moisture from all of the room in the house will migrate naturally towards the dehumidifier and be processed.
- If there is a problematic area or a room in a high humidity level, use a hygrometer to measure (available to purchase at ecoair.org) in the property, you may wish to place it in that area initially. Once the problem is settled you may wish to relocate to the location above.
- Please refer to the important safeguards on the previous pages when positioning the dehumidifier, such as a safe distance away from the wall, avoid confined areas, ensure floor is even and level surface.

INSTALLING THE DEHUMIDIFIER

- Unpack the dehumidifier and plug in to the socket.
- Ensure there is a minimum distance of 40 cm around the dehumidifier.
- Check that the dehumidifier is level to avoid any water leaks.
- Turn on the dehumidifier to start dehumidification.

ZEOLITE

- When you first use the dehumidifier and periodically thereafter you may notice a smell coming from the dehumidifier. This is caused by the Zeolite desiccant material and is NOT a sign that the dehumidifier is faulty, nor is it harmful to humans or pets.
- The Zeolite absorbs odours from items such as cigarettes, cosmetics, hair sprays, building materials and new furniture and then when the desiccant is heated the smell is discharged into the room. (This smell has been described as being like a burning smell or a sour smell). This is normal and will NOT last long, nor is it a sign of a fault.

INITIAL OPERATION

- When you first use your dehumidifier it will work hard to reduce the room humidity to your set target humidity. This is the time when it will produce most of the water and need emptying more frequently. As the room become dryer, the dehumidifier collects less water. This is normal.
- Once the power is restored after a power failure, the dehumidifier will continue to operate at the selected settings prior to the power failure.

SETUP CONTINUOUS DRAINAGE

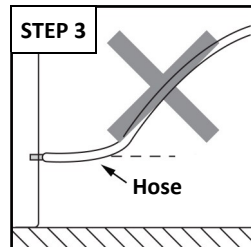
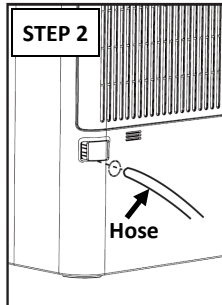
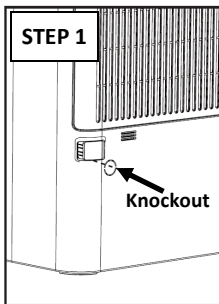

Use a hose with an inner diameter of 11.5mm for continuous drainage:

1. Use a screwdriver to remove the knockout (A9) at the back.
2. Ensure the water tank is well fitted in position. Then, push the hose (B1) through the knockout (A9) and make sure it attaches firmly to the open tap securely.
3. Once the hose is securely attached to the open tap, lead the other end of the hose to an appropriate drain at a downward slope with no sharp bends.

NOTE:

- When using the dehumidifier with a continuous hose attached, never pull out the tank. If you need to remove the water tank, ensure that the hose is disconnected.
- Never leave the end of continuous drainage hose outside when the temperature is below 1°C to avoid leakage. (When the outdoor temperature is at freezing point the water will not flow freely and this will cause a blockage consequently pushing the any condensation back to the dehumidifier and leakage will occur).

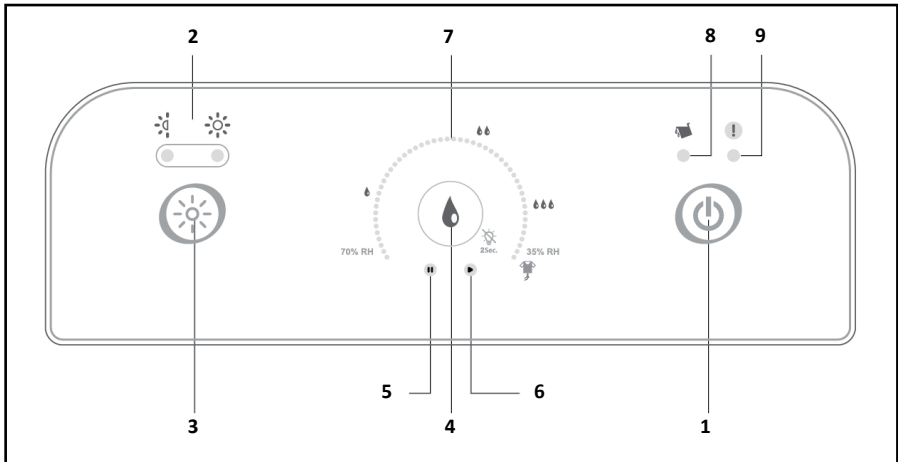

CONTROL PANEL





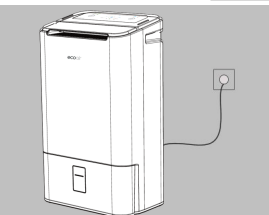

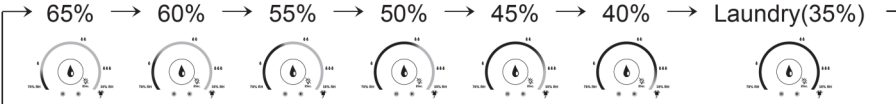
1. **Power Key** - Turn unit on ON/OFF.
2. **Mode Setting** - Select **TURBO** ☀️ or **ECONOMY** ☁️ settings.
3. **Mode Indicator** - **ECONOMY** ☁️ setting or **TURBO** ☀️ setting
4. **Humidistat Setting** 💧 - Press the water droplet in the middle of the dial to toggle for the following (7 Steps).
 - **LOW** 💧 (3) Steps
 - **MEDIUM** 💧💧 (3) Steps
 - **HIGH** 💧💧💧 (1) Step
 - **LAUNDRY / CONTINUOUS MODE** 🧺 settings.
5. **Pause Indicator** - Ambient humidity is below the Set Humidity, the unit will go into standby mode. Occasionally the unit will turn on the fan to circulate the air
6. **Resume Indicator** - Ambient humidity is above the Set Humidity
7. **Humidity Indicator** - The indicator shows the ambient humidity level.
8. **Water Full Indicator** - Water tank is full or incorrectly inserted.
9. **Check Light Indicator** - Indicator lights up when the unit needs attention.







OPERATION

ON/OFF 	
TO OPERATE UNIT	<ul style="list-style-type: none"> Place the unit in an upright position on an even level surface. Plug the unit into the mains socket. Position the louver 45 degree angle Press the ON/OFF button to operate the unit. Now select Mode. To switch the unit OFF, Press the ON/OFF button. Note the fan will run for 2 minutes, to help cool and protect the internal components. (TIP: do not unplug the power socket until the fan stops) 

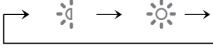
HUMIDITY SETTING 	
<p>• Press the "HUMIDITY" setting button to set the mode in the following loop. The LED display will guide you.</p> <p>65% → 60% → 55% → 50% → 45% → 40% → Laundry(35%)</p> 	
<p>The dehumidifier will start (with green RUN  LED on) when humidity setting is lower than the room humidity.</p> <p>When the humidity setting is higher than the room humidity or when room humidity reaches the setting, the yellow PAUSE  LED will light up and the machine is in an energy saving pause state (HEATER turns OFF, the machine stops after 2 minutes of cooling operation). If the humidity is higher than 5% of the set value, the machine will restart.</p> <p>After 30 minutes pause, the fan will run for 2 minutes to check indoor humidity. The dehumidifier will work when the humidity level is 5% above the wanted level. If levels are still good it will wait another 30 minutes. During the pause, buttons are settable though the fan stops.</p>	

 Low	<ul style="list-style-type: none"> Select to run in Low mode Dries the air to approximately 60% - 70% RH and stops dehumidifying.
 Medium	<ul style="list-style-type: none"> Select to run in Medium mode Dries the air to approximately 50% RH and stops dehumidifying.
 High	<ul style="list-style-type: none"> Select to run in High mode to quickly control high level of humidity Dries the air to approximately 40% RH and stops dehumidifying.
 Laundry Mode	<ul style="list-style-type: none"> Use for drying clothes. The dehumidifier will continuously dry the air until the settings are changed manually. It typically takes 2 – 4 hours to dry your laundry. Place the laundry on a drying rack with a minimum distance of 40cm away from the dehumidifier Only use the Laundry Mode function over a short period of time. Avoid using the laundry mode

OPERATION

MODE SETTING	
<ul style="list-style-type: none">Press the MODE button to select modes in the following loop: 	
<p> : the machine runs with low fan speed and low heater.</p> <p> : the machine runs with high fan speed and high heater.</p>	
SLEEP (DIMMED) MODE 	
<ul style="list-style-type: none">Press the Humidity button for 2 seconds to turn-on and off a SLEEP mode. The LEDs for the humidity display, mode display and buzzer (beeps of button operation) will be turned off, but only the RUN or PAUSE LED in half brightness and the buzzer still works for Power.	
CHECK LIGHTS	
 Water Full Indicator	<ul style="list-style-type: none">Lights up when water tank is full or not properly inserted.
 Check Indicator	<ul style="list-style-type: none">Filter needs cleaning.Dehumidifier needs to cool down. Switch OFF and leave for 30 minute and turn on again. This is normal.In low humidity or temperature conditions.In high temperature condition over 40°C or low temperature below 1°C.
<ul style="list-style-type: none">TIP: When the check indicator comes on, remove the plug from the socket. Move the unit to another room after it cools down or when conditions allow.	

EMPTYING THE WATER TANK

STEP 1

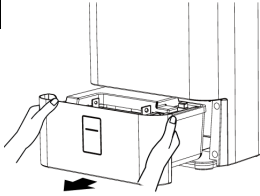

Remove water tank

STEP 2

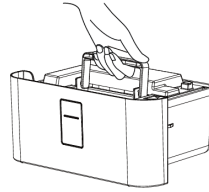

Lift by the handle

STEP 3

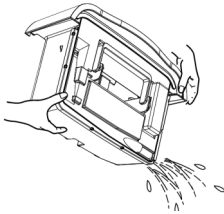

Pour the water away

STEP 4

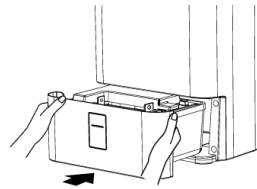

Insert the water tank

The Water level Indicator lights up when the water tank is full. The appliance will stop operating. Allow to stand for approximately 30 minutes to ensure all water has drips into the water tank before removing the tank.

1. Remove the Water Tank (**A11**) by the grip recess on both sides
2. Lift by the handle gently.
3. Pour the water away
4. Clean the Water Tank (**A11**), restore the cover and handle. Towel dry the water tank.
5. Insert the water tank back into to the correct position. The Water Full light indicator illuminates if the water tank is not correctly in position. If this happens, gently reinsert again.

NOTE :

- Clean the water tank with mild detergent if necessarily. Do not use solvent, abrasive or hot water.
- When cleaning the water tank, take caution to avoid damaging the float.
- Do not tilt the dehumidifier when removing the water tank. This is to prevent water leaking which may cause electric shock.

In the unlikely event of a problem with your product, please refer in the first instance to:
ECOAIR TECHNICAL SUPPORT
www.ecoair.org/support

CLEANING, MAINTENANCE & STORING THE APPLIANCE

STEP 1 - CLEANING YOUR FILTER (A8)

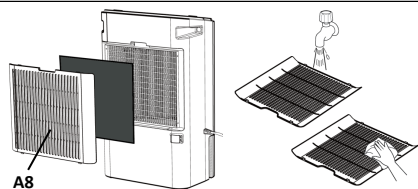

1. Turn off and leave for 5 minutes, then unplug the dehumidifier. Remove the filter.
2. Clean the filter with a brush or vacuum cleaner. (Washing will weaken the germicidal effect of the filter).
3. Reinsert the filter back into position.

Tip: Clean your filter every 2 weeks to keep your air clean and prolong the life of your dehumidifier. The frequency will depend on conditions of operation. Filter must be cleaned every 2 weeks to avoid dust build up internally that will cause malfunction.

Note: If the filter is covered with dust, the airflow and the performance of the dehumidifier will be

STEP 3 - CLEANING YOUR DEHUMIDIFIER

1. Turn off and leave for 5 minutes, then unplug the dehumidifier.

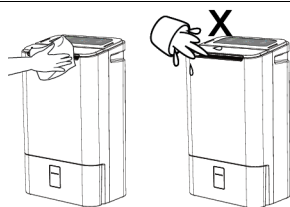

2. Clean the surface with a soft damp cloth.
3. Dry thoroughly with a towel after cleaning.
4. For cleaning tank, see Emptying the Water Tank section.

Caution:

- Do not wash the unit or immerse in water.
- Do not let water drip into the air inlet or outlet.
- When cleaning the water tank, take caution to avoid damaging the float.

STEP 2 - REPLACING YOUR FILTER

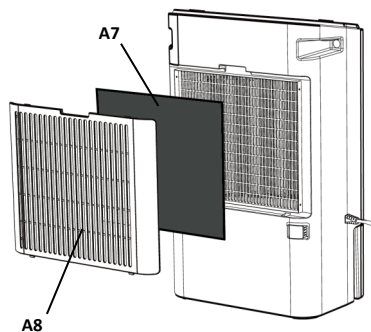

There is one filter provided with the dehumidifier.

1. The **(A8)** Silver Nano Filter is factory-installed in the dehumidifier.
2. The **(A7)** Optional Active Charcoal filter can be used in addition to the Pre-Filter (Purchase Separately).

It is recommended that both filters is replaced every 6 months for optimal performance and hygiene standards. To purchase a replacement filter please visit: www.ecoair.org



Active Charcoal Filter is very effective at removing chlorine, volatile organic compounds (VOC) and odours.

STEP 4 - STORING YOUR DEHUMIDIFIER

1. Turn off the dehumidifier, wait 5 minutes and unplug the dehumidifier from the power socket.
2. Leave the dehumidifier to drain for approximately one day. Clean and dry the water tank.
3. Clean the filter and the dehumidifier. Cover the dehumidifier to prevent it from gathering dust. Store upright in a cool dry place.
4. Do not expose to direct sunlight.

TROUBLESHOOTING

CHECK THE FOLLOWING POINTS BEFORE CONTACTING TECHNICAL SUPPORT.

PROBLEM	REASON	SOLUTION
No Power	Dehumidifier is not plugged in or there is no power supply	Plug the dehumidifier into mains and switch plug ON. Check the main power supply
 Check Light On	Filter clogged	Check and clean or replace the filter
	The air inlet or outlet is blocked or covered	Remove obstructions or request a service
	Dehumidifier is overheating due to dust build-up	The dehumidifier requires a service. Contact Ecoair Support.
	Low humidity condition	Switch off unit and move to another room
 Water Full Light On	Water tank is full or installed incorrectly	Empty water tank or re-install correctly
	Water float out of position	Restore water float back into position
Water Leaking	Dehumidifier on uneven surface or water tank fitted incorrectly	Ensure the dehumidifier is on a flat, even surface, use a spirit level to check, remove tank and replace correctly
	Filter clogged	Clean or replace filter
	Damaged water tank	Remove the water tank, fill with water and place on a hard even surface to test for leakage
	The continuous drainage is clogged or loose	Check the continuous drainage hose and its connection
Not Collecting Water	Set humidity is reached	Readjust the humidity settings
	Room is very cold or very dry for the current settings	Readjust the humidity setting or increase the room temperature Check room temperature and humidity levels
	Filter dusty	Clean the air filter or replace it
	Dehumidifier set up incorrectly	Ensure unit is set up correctly
	Room Temperature is too hot Room Temperature is too cold	Open the window or door to ventilate Increase heat in the room
Noisy	Water tank or filter fitted incorrectly	Check and refit the water tank or filter Check unit is on an even level surface
	Foreign object fallen through the vent into the dehumidifier	Contact support @ EcoairGB.com for Ad Hoc service
	Dehumidifier placed on uneven surface	Place on an even surface. If necessary test with a spirit level.