

---

**COMPRESSOR DEHUMIDIFIER**

**USER MANUAL**

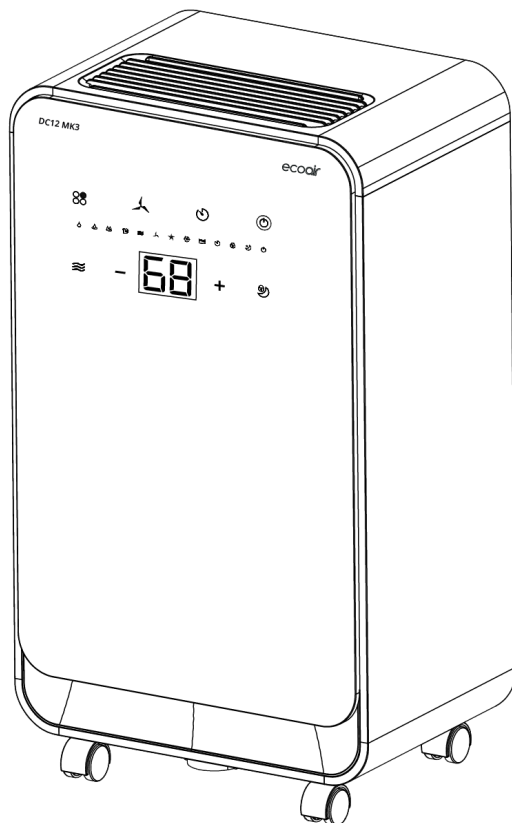

**DISPOSAL**



The appliance must not be disposed of with household waste, but taken to an authorised waste separation and recycling centre.

Please read instructions before use  
Keep for future reference

Visit [ecoair.org](http://ecoair.org) to register your product  
or terms and conditions

# WELCOME

Thank you and congratulations for choosing an EcoAir dehumidifier to help you improve the air quality within your environment. Inside you will find many helpful tips on how to use and maintain your dehumidifier efficiently. Just a little preventative care can save you money and prolong the life of your dehumidifier.

The purpose of the dehumidifier is to remove the excess moisture in the air by detecting the humidity level in the room. By keeping humidity within recommended levels, a dehumidifier combats household damp, mould and mildew. Dehumidifiers can help to reduce the symptoms of asthma, allergies, and other respiratory health conditions. They can also be used to help dry laundry quicker and control moisture-based damage (such as the aftermath of flooding, leaks or rising damp) to valuable belongings and furniture.

## HUMIDITY GUIDE

There will always be water vapour in the air. The water vapour (or commonly known as moisture) in the air is measured in Relative Humidity (RH) %. RH is the ratio of the actual amount of water vapour in the air to the amount it could hold when saturated expressed as a percentage. Too much or too little moisture in our homes can be unhealthy and uncomfortable. The optimum humidity level is between 40% and 60% (RH) where we feel most comfortable.

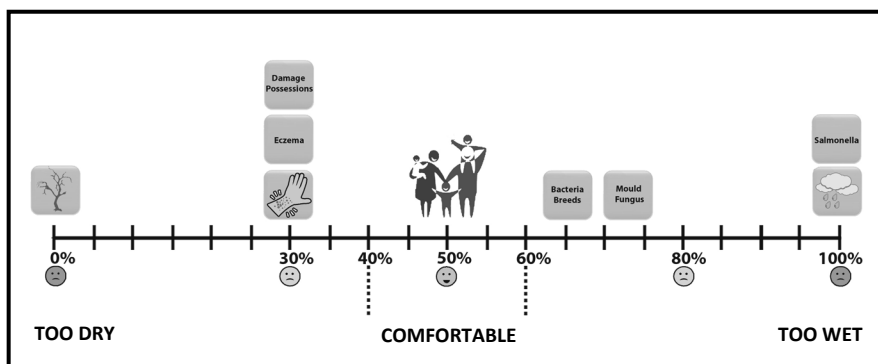

### Low humidity

Low humidity indoors causes excess drying which can trigger skin irritations such as eczema, chapped skin and dry nose. It can also damage possessions, such as wooden furniture, musical instruments and artwork by drying it out too much.

### High humidity

High humidity indoors causes damp and condensation. The damp left by condensation can damage plaster, wall paper, furniture, vehicles, timber windows, doors and clothes. It can be harmful to our health when bacteria thrives, causing mould and fungus.

### Maintaining safe levels of humidity

It is important to maintain a consistent humidity range to preserve furniture, paintings, door and window frames. High humidity causes swelling, corrosion, softening of glues and paint. Low humidity causes shrinking, cracking, warping of wood surfaces and gaps in joints, doors and windows. Frequent changes in humidity levels can accelerate damages to property and belongings.

### Condensation

The warmer the air, the more moisture the air can hold than colder air. So, when the air inside the house becomes colder, the moisture contents in the air becomes saturated, and gets heavier resulting in moisture concentration on the coldest parts of the house particularly on the windows, bathroom mirrors and walls. This is condensation, caused by a sudden increase in humidity, cooking, showers, drying clothes, inadequate ventilation and poor thermal insulation.

Condensation does not disappear instantly even with the dehumidifier on. Where excessive condensation appears for example, on your windows, you may want to open your windows to expel the excess humidity for several minutes. It will take a while for the condensation to generally increase the humidity in the room. Once the humidity level in the room around the dehumidifier is increased above the level you have set on the dehumidifier, it will then begin the dehumidification process.

## INDEX

---

Important Safety Instructions	1
Refrigerant R290	2
The Appliance and Accessories	4
Important Safeguards	5
Installation	6
Setup Continuous Drainage	7
Control Panel	8
Operation	9 - 10
Emptying the Water Tank	11
Cleaning, Maintenance and Storing the appliance	12
Troubleshooting	13 - 14

## IMPORTANT SAFETY INSTRUCTIONS

---

### WARNING!

This dehumidifier is intended for use in domestic households and similar working and residential environments and is not intended for outdoor use. It must be used only as a domestic appliance. EcoAir cannot be held liable for damage resulting from incorrect or improper use or operation.

- Do not alter or modify the appliance's characteristics in any way. Should repairs be necessary, contact EcoAir's Authorised Service Centre. Self-servicing or unauthorised servicing can be dangerous.
- The appliance must be installed in accordance with the relevant national legislation.
- The appliance is not intended for use by persons (including children) with reduced physical, sensory or mental capabilities, or lack of experience and knowledge, unless they have been given supervision or instruction concerning the use of the appliance by a person responsible for their safety.
- Children and pets should be supervised to ensure they do not play with the appliance.
- Do not use the appliance if the power cable, cord is damaged. It must be replaced by an EcoAir's Authorised Service Centre.
- The appliance must always be placed in an upright position on an even level surface to avoid any damage, during use or transportation and when put into storage.
- The appliance must be plugged into a grounded 3-prong outlet and ensure that the voltage matches the rated specifications. If in doubt, check with a qualified technician.
- Do not use with extension cables or multi sockets. Do not pull or place strain on the power cord when moving appliance.
- Always unplug the appliance before cleaning or maintenance or when not in use.
- The appliance must not be placed or used where the atmosphere may contain combustible gasses, oil or sulphur or solvent, or near heat sources (such as heaters or in server rooms) or excessive dust.
- Do not place or rest any objects on the appliance and do not cover while in use. Always observe the minimum room size for storing and operating the appliance.
- Allow a minimum of 40 cm clearance around the appliance. Do not place any objects in close proximity to the appliance.
- Filter must be cleaned every 2 weeks to avoid dust building up internally causing overheating and malfunction.
- To protect against electric shocks, do not immerse or spray the appliance or any of its parts in water.
- Ensure the air inlet and outlet are not blocked or covered when in use.
- Do not insert fingers or any objects into the air inlet or outlet openings.
- Do not operate or store the appliance under direct sunlight.
- Always switch of the power before unplugging from the socket.
- Do not leave the appliance running or plugged in over a long period of time unattended. Leaving unattended electrical appliances running is unsafe.
- Always make sure your hands are dry when operating the appliance.
- Only operate the appliance within the specified operating temperature range.
- Do not run power cord under carpeting, or cover with rugs or runners. Arrange the cord away from areas where it may become a trip hazard.
- The appliance is manufactured for dehumidification in domestic environments and must not be used for other purposes.
- This appliance must not be used outdoor or wet areas such as bathrooms.
- Do not use the Laundry Mode function over a long period of time or unattended. When drying laundry, do not place laundry on the appliance. Always ensure the laundry is placed a safe distance from the dehumidifier at least 40cm.
- Keep the unit upright for 4 hours before switch on first time.
- The model works within ambient temperatures of 15°C to 35°C.

## REFRIGERANT R290

---



R290

This appliance contains R290 Refrigerant Gas

Our dehumidifier contain the non-polluting refrigerant R290 with no harm to our ozone, it helps reduce global warming potential. This refrigerant complies with the European Environmental Directives.

There are some important safety precautions that you need to follow :-

1. Do not use these appliances in rooms smaller than shown in table below for each of the models to prevent fire, explosions.



Model	Minimum Floor Area (m <sup>2</sup> )	Contains R290 (Grams)
DC12 MK3	4m <sup>2</sup>	40g

2. Do not use these appliances in a room with continuous sources of ignition such as open flames, gas appliances, electric heaters, cigarette smoking and other sources of ignitions.
3. Always store these appliances in a well-ventilated area with a minimum size shown in the above table.
4. Keep any required ventilation openings clear of obstructions.
5. Never attempt to service or repair the appliances yourself, always ensure it is only serviced by a EcoAir approved engineer using original EcoAir parts.
6. If these appliances are installed, operated or stored in a non-ventilated area, then the room must be designed to prevent the accumulation of refrigerant leaks. Accumulation of refrigerant leaks in a non-ventilated area can be ignited by other causes such sparks or smoking or open flames from other appliance or causes such as electric heaters, stoves or other sources of ignition in the area.

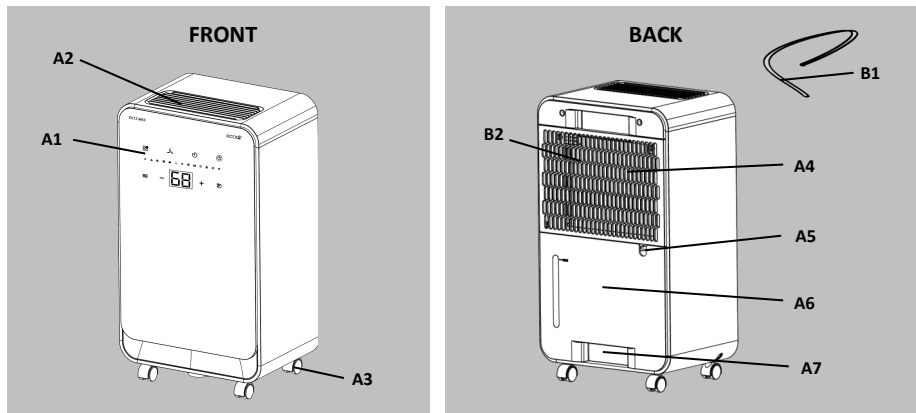
## THE APPLIANCE & ACCESSORIES

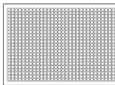

### Accessories List

		
B1	B2 (Optional)	B3

DESCRIPTION	
Key	Description
A1	Control Panel
A2	Air Outlet
A3	Castors
A4	Air Inlet / Air Filter
A5	Continuous Drainage Knockout
A6	Water Tank
A7	Tank Grip Recess
Key	Description
B1	Continuous Drainage Hose
B2	Carbon Filter (Optional)
B3	User Manual

# IMPORTANT SAFEGUARDS

## WHERE TO POSITION YOUR DEHUMIDIFIER?

Ensure the unit is a safe distance away from a wall or furniture and away from direct sunlight.

**TIP:** Position the dehumidifier in the dampest room or somewhere central like a landing or a hallway. As long as the internal doors are open the excess moisture from all of the rooms in the house will migrate naturally towards the dehumidifier and be processed.

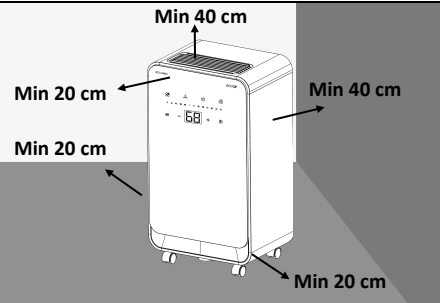

## DO NOT PLACE OBJECTS ON OR OVER THE APPLIANCE

Ensure the air inlet (A4) and air outlet (A2) are not obstructed. Obstruction will cause overheating and malfunction.

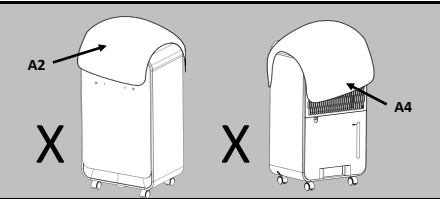

## DRYING YOUR LAUNDRY

Never place wet laundry over the appliance. Dry the laundry on a rack with a minimum distance of 40 cm.

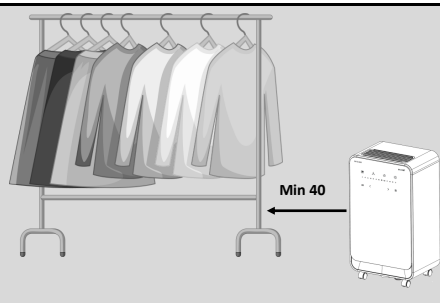

## ROOM SIZE

- Never use in small confined area. (Broom cupboard, boiler room, unventilated rooms, in close proximity to a heat source such as heater, tumble dryer, cooker). Minimum room size 4m<sup>2</sup>.

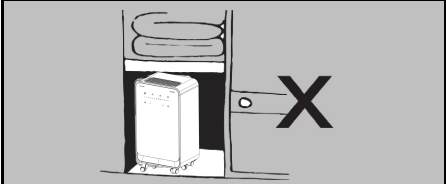

## DO NOT SPLASH

- Do not wash the appliance or immerse in water
- Do not allow water to drip on to the appliance

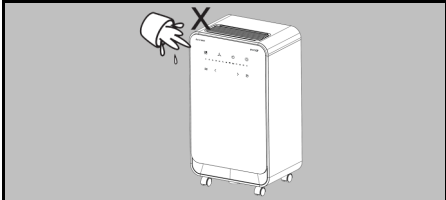

## PLACE ON EVEN LEVEL FLOOR

- Always operate appliance on an even level floor to avoid leakage
- If appliance is on carpet, ensure the appliance is stable and level

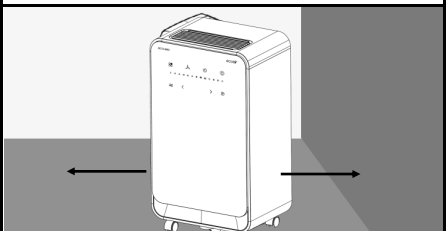

## IMPORTANT

- Do not move the appliance or remove the water tank when the dehumidifier is running. It may cause damage, electric shock, water leak or spills.
- After turning the dehumidifier off, the fan will continue to run for 2 minutes. This is to help to cool and protect the internal components. During these 2 minutes, do not remove the power plug from the power socket, wait for the fan to stop.
- Dusty, building sites or an industrial environment where particles can clog up the filter or internal components.

# INSTALLATION

## PLEASE READ IMPORTANT SAFEGUARDS BEFORE INSTALLATION

### FIND A SUITABLE POSITION

- Position the dehumidifier in the dampest room or somewhere central like a landing or a hallway. As long as the internal doors are open, the excess moisture from all of the room in the house will migrate naturally towards the dehumidifier and be processed.
- If there is a problematic area or a room in a high humidity level, use a hygrometer to measure (available to purchase at [ecoair.org](http://ecoair.org)) in the property, you may wish to place it in that area initially. Once the problem is settled you may wish to relocate to the location above.
- Please refer to the important safeguards on the previous pages when positioning the dehumidifier, such as a safe distance away from the wall, avoid confined areas, ensure floor is even and level surface.

### INSTALLING THE DEHUMIDIFIER

- Unpack the dehumidifier and plug in to the socket.
- Ensure there is a minimum distance around the dehumidifier.
- Check that the dehumidifier is level to avoid any water leaks.
- Turn on the dehumidifier to start dehumidification.

### INITIAL OPERATION

- When you first use your dehumidifier it will work hard to reduce the room humidity to your set target humidity. This is the time when it will produce most of the water and need emptying more frequently. As the room become dryer, the dehumidifier collects less water. This is normal.
- Once the power is restored after a power failure, the dehumidifier will continue to operate at the selected settings prior to the power failure.



## SETUP CONTINUOUS DRAINAGE

---

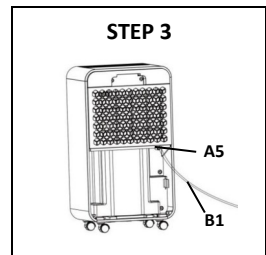
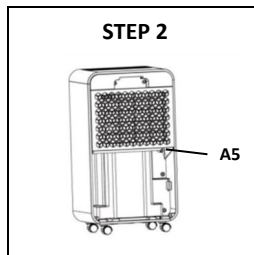
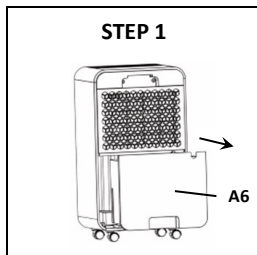

### Use a hose with an inner diameter of 10mm for continuous drainage:

1. Remove Water Tank (A6) from the back of the dehumidifier (Step 1)
2. Remove the knockout (A5) from the back of the dehumidifier (Step 2)
3. Insert the Continuous Drainage Hose (B1) through the knockout (A5) and make sure it attaches firmly to the open tap securely. The hose must lead to an appropriate drain at a downward slope with no sharp bends. (Step 3)

#### NOTE:



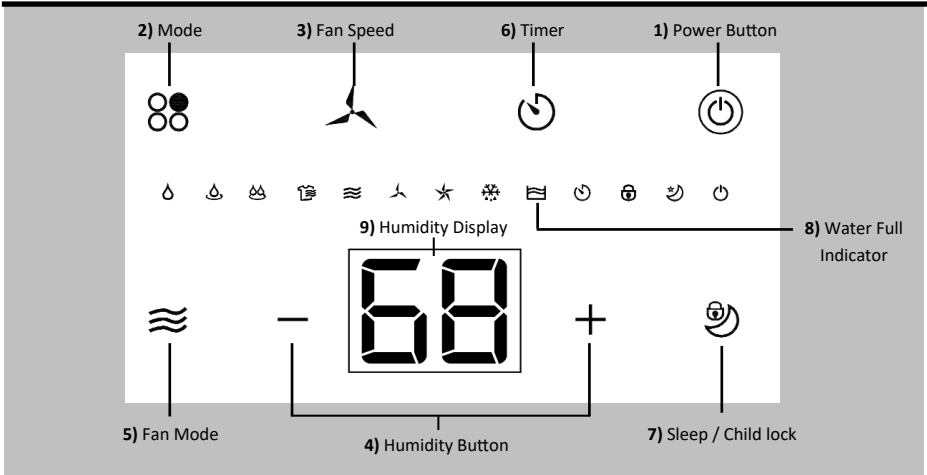

- Ensure the water tank and continuous drainage hose are well fitted in position before commencing operation.
- Never leave the end of continuous drainage hose outside when the temperature is below 1°C to avoid leakage. (When the outdoor temperature is at freezing point the water will not flow freely and this will cause a blockage consequently pushing the any condensation back to the dehumidifier and leakage will occur).

## CONTROL PANEL



1. **Power Button** - Turns dehumidifier **ON** or **OFF**. Please note when turning off, the compressor will stop, but the fan will continue to run for a further 10 seconds.

2. **Mode Button** -

-  1) Manual - Select humidity ( +/ - ) between 30% - 80% at 5% interval and select fan speed (High or Low).
-  2) Auto-Low - On low fan, humidity range 35% to 50%
-  3) Auto-High - On high fan, humidity range 35% to 50%
-  4) Laundry Mode - Continuous on high fan for laundry

3. **Fan Speed** - Select for High or Low fan speed. When using  and 

4. **Humidity Button** - Tap to set your desired humidity level - each tap will increase the humidity by 5%RH up to maximum of 80%RH. Humidity can only be changed when in One Drop Mode 

5. **Fan Mode** - Fan only (will not dehumidify).

6. **Timer key** - Select timer OFF. The timer can be set for hourly intervals from 1 to 24 hours.





7. **Sleep / Child lock Button** - Sleep mode will turn display light off. Press and hold this button for 5 seconds to toggle the child lock function.

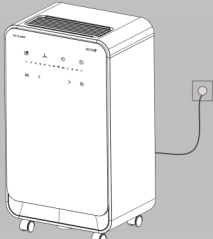

8. **Water Full Light Indicator** - Lights up when the water tank is full, inserted incorrectly or tank was removed.

9. **Humidity Display Panel** - The display on the dehumidifier by default shows the **ambient humidity** level whilst the dehumidifier is running.

# OPERATION

ON/OFF 	
<b>TO OPERATE UNIT</b>	<ul style="list-style-type: none"> <li>Always place the dehumidifier in an upright position on an even level surface.</li> <li>Plug the dehumidifier into the mains socket, the standby mode indicator will remain on whilst the dehumidifier is plugged in to the mains.</li> <li>The dehumidifier performs best at a minimum ambient temperature of 15°C. Where ambient temperature is below 15°C it will need to go into defrost mode periodically to preserve the life of the compressor.</li> <li>Press the ON/OFF button to operate the dehumidifier.</li> <li>Operate within an ambient temperature of 15°C to 35°C.</li> </ul>
	

1 DROP / 1 DROP CONTINUOUS / 2 DROP CONTINUOUS / LAUNDRY MODE	
 <b>1 Drop</b>	<ul style="list-style-type: none"> <li>Manual Mode, humidity and fan speed can be manually adjusted.</li> </ul>
 <b>1 Drop</b>	<ul style="list-style-type: none"> <li>Auto-Low Mode, low fan speed with humidity range 35% to 50%.</li> </ul>
 <b>2 Drop</b>	<ul style="list-style-type: none"> <li>Auto-High Mode, high fan with humidity range 35% - 50%.</li> </ul>
 <b>LAUNDRY MODE</b>	<ul style="list-style-type: none"> <li>Used for drying clothes. The dehumidifier will continuously dry the air at high mode until you switch to one of the above modes.</li> </ul>

HUMIDITY BUTTON 	
	<ul style="list-style-type: none"> <li>Select for the desired humidity.</li> <li>touch this button to change the set humidity.</li> </ul> <p>The set humidity range is 30% - 35% - 40% - 45% - 50% - 55% - 60% - 65% - 70% - 75% - 80%</p>
<p>There is an active humidistat which shows the actual humidity level (%RH) in the environment when the dehumidifier is running.</p>	
<p>The display will show the actual humidity in the room a few seconds after the humidity level is set on the control panel.</p>	

AUTO DEFROSTING	
	<ul style="list-style-type: none"> <li>When frost builds up on the evaporator coils, the compressor will pause to defrost and the fan will continue to run until the frost disappears.</li> </ul>

# OPERATION

TIMER	
SETTING TIMER OFF	
<p>Press the "TIMER" Key to select your desired running time</p>	
	<ul style="list-style-type: none"> <li>• Whilst the dehumidifier is in operation press the timer button to set the dehumidifier to turn off after a set interval between 0-24hrs (1hr Increments)</li> <li>• Once set, the timer LED will remain on until the set interval is met and the dehumidifier turns off.</li> <li>• Once the dehumidifier is switched off, wait 3 minutes before resuming operation.</li> </ul>
<p><b>Note:</b> Wait 3 minutes before resuming operation. After the dehumidifier has stopped (other than tank full) it will not restart for approximately 3 minutes. This is to protect the dehumidifier and is not a fault. Operation will automatically restart after 3 minutes.</p>	

TIPS	
	<ul style="list-style-type: none"> <li>• The dehumidifier is factory pre-set to 60%RH. It will not immediately operate if your environment is below 60%RH. Change the humidity setting to below the ambient humidity to begin operation.</li> </ul>
<p>Note: If connected to the continuous drainage hose the dehumidifier will continue to run on its maximum dehumidification settings.</p>	

TANK FULL INDICATOR	
	<ul style="list-style-type: none"> <li>• Indicator lights up when water tank is full or incorrectly inserted. The dehumidifier will automatically switch off. The indicator light will turn red and the dehumidifier will beep.</li> <li>• Remove water tank, empty and reinsert correctly.</li> </ul>
<p><b>Note:</b></p> <ul style="list-style-type: none"> <li>• When the water tank is full or removed, the controls are disabled.</li> </ul>	
USEFUL INFORMATION	
<ul style="list-style-type: none"> <li>• When you first use your dehumidifier set to laundry mode to reduce the humidity quickly to your desired level. As the humidity settles, use the low fan setting.</li> </ul>	
<ul style="list-style-type: none"> <li>• When you set the Timer Off, the dehumidifier may turn off prior to the set interval if it has reached the set humidity.</li> </ul>	
<ul style="list-style-type: none"> <li>• To cancel the timer setting press the Timer button until you reach "00".</li> </ul>	
<ul style="list-style-type: none"> <li>• <b>Auto Restart</b> - Once the power is restored after a power failure, the appliance will continue to operate at the selected settings prior to the power failure.</li> </ul>	
<ul style="list-style-type: none"> <li>• <b>Auto shut off</b> - The dehumidifier will automatically switch off when the tank is full or removed and when humidity setting is reached.</li> </ul>	

## EMPTYING THE WATER TANK

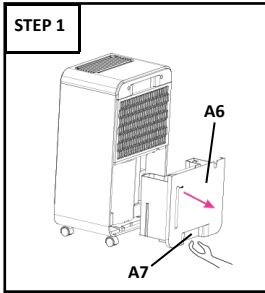

Slide water tank out

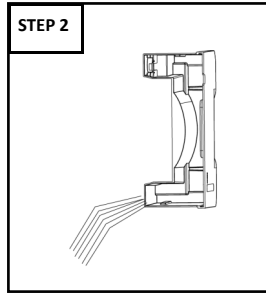

Pour the water away

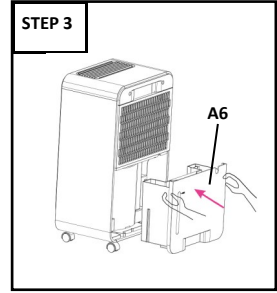

Slide water tank in

The Water level Indicator lights up when the water tank is full. The appliance will stop operating. Allow to stand for approximately 10 minutes to ensure all water collected drips into the water tank before removing the tank.

1. To remove the Water Tank (A6), slide it out gently by gripping the water tank from bottom Grip Recess (A7).
2. Pour the water away by tilting the water tank, (see step 2 picture) to the right side. Clean the water tank if needed.
3. Insert the water tank (A6) back into to the correct position. The Water Full light indicator illuminates if the water tank is not correctly in position. If this happens, reinsert again.

### NOTE :

- Clean the water tank with mild detergent if necessarily. Do not use solvent, abrasive or hot water.
- When cleaning the water tank, take caution to avoid damaging the float.
- Do not tilt the dehumidifier when removing the water tank. This is to prevent water leaking which may cause electric shock.

## CLEANING, MAINTENANCE & STORING THE APPLIANCE

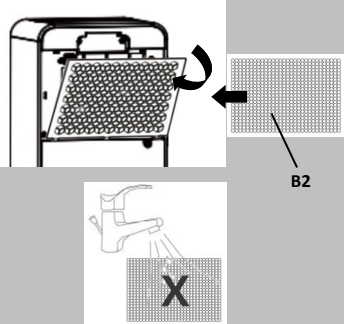
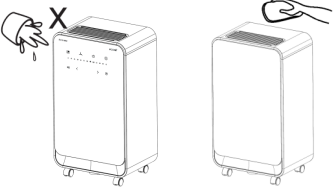
STEP 1 - CLEANING YOUR FILTER	STEP 2 - REPLACING YOUR FILTER
	
<ol style="list-style-type: none"> <li>1. Turn off and leave for 5 minutes, then unplug the dehumidifier. Remove the filter.</li> </ol>	<p>Carbon Filter (<b>B2</b>) can be purchased for this dehumidifier. Insert the carbon filter in between the frame filter and the dehumidifier. Do not clean the Carbon Filter with water!</p>
<ol style="list-style-type: none"> <li>2. Clean the filter with a brush or vacuum cleaner. (Washing will weaken the germicidal effect of the filter).</li> </ol>	<p>It is recommended that the outer filter is replaced every 6 months for optimal performance and hygiene standards. To purchase a replacement filter please visit: <a href="http://www.ecoair.org">www.ecoair.org</a></p>
<ol style="list-style-type: none"> <li>3. Reinsert the filter back into position.</li> </ol>	
<p><b>Tip:</b> Clean your filter every 2 weeks to keep your air clean and prolong the life of your dehumidifier. The frequency will depend on conditions of operation.</p> <p><b>Note:</b> If the filter is covered with dust, the airflow and the performance of the dehumidifier will be affected.</p>	
STEP 3 - CLEANING YOUR DEHUMIDIFIER	STEP 4 - STORING YOUR DEHUMIDIFIER
<ol style="list-style-type: none"> <li>1. Turn off and leave for 5 minutes, then unplug the dehumidifier.</li> </ol>	<ol style="list-style-type: none"> <li>1. Turn off the dehumidifier, wait 5 minutes and unplug the dehumidifier from the power socket.</li> </ol>
	<ol style="list-style-type: none"> <li>2. Leave the dehumidifier to drain for approximately one day. Clean and dry the water tank.</li> </ol>
<ol style="list-style-type: none"> <li>2. Clean the surface with a soft damp cloth.</li> </ol>	<ol style="list-style-type: none"> <li>3. Clean the filter and the dehumidifier. Cover the dehumidifier to prevent it from gathering dust. Store upright in a cool dry place.</li> </ol>
<ol style="list-style-type: none"> <li>3. Dry thoroughly with a towel after cleaning.</li> </ol>	
<ol style="list-style-type: none"> <li>4. For cleaning tank, see Emptying the Water Tank section.</li> </ol>	
<p><b>Caution:</b></p> <ul style="list-style-type: none"> <li>• Do not wash the unit or immerse in water.</li> <li>• Do not let water drip into the air inlet or outlet.</li> <li>• When cleaning the water tank, take caution to avoid damaging the float.</li> </ul>	<ol style="list-style-type: none"> <li>4. Do not expose to direct sunlight.</li> </ol>

## TROUBLESHOOTING

### CHECK THE FOLLOWING POINTS BEFORE CONTACTING TECHNICAL SUPPORT.

PROBLEM	REASON	SOLUTION
<b>No Power</b>	Dehumidifier is not plugged in or there is no power supply	Plug the dehumidifier into mains and switch plug ON. Check the main power supply
	Dehumidifier has reached its pre-set level or tank is full.	The dehumidifier automatically turns off when either condition occurs. Change to a lower humidity setting or empty the tank and replace properly.
	Water tank is not in the proper position.	The water tank must be in place and securely seated for the dehumidifier to operate.
	Power failure/Controls cannot be set	There is a protective time delay to protect the compressor. For this reason, the dehumidifier may not start normal dehumidifying for 3 minutes after it is turned back on.
<b>The Dehumidifying function does not work</b>	Filter clogged	Check and clean or replace the filter
	The air inlet or outlet is blocked or	Remove obstructions
<b>Water Full Light On</b>	Water tank is full or installed incorrectly	Empty water tank or re-install correctly
	Water float out of position	Restore water float back into position
	Dehumidifier on uneven surface or water tank fitted incorrectly	Ensure the dehumidifier is on a flat, even surface, use a spirit level to check, remove tank and replace correctly
<b>Water Leaking</b>	Damaged water tank	Remove the water tank, fill with water and place on a hard even surface to test for leaking.
	The continuous drainage is clogged or loose. Dehumidifier operating in colder environment	Check the continuous drainage hose and its connection Ensure room is within operating temperatures
<b>Not Collecting Water</b>	Did not allow enough time to remove moisture	When first installed, allowed at least 24 hours to maintain the desired dryness
	Set humidity is reached/ Low humidity	Readjust the humidity settings
	Room is very cold or very dry for the current settings	Readjust the humidity setting or increase the room temperature Check room temperature and humidity levels
	Filter dusty	Clean the air filter or replace it
	Room Temperature is too hot	Open the window or door to ventilate
	Room Temperature is too cold	Increase heat in the room

In the unlikely event of a problem with your product, please refer in the first instance to:

**ECOAIR TECHNICAL SUPPORT** : [www.ecoair.org/support](http://www.ecoair.org/support)  
**PRODUCT MANUAL GO TO** : [ecoair.org/pages/help-and-support](http://ecoair.org/pages/help-and-support)

## TROUBLESHOOTING

---

CHECK THE FOLLOWING POINTS BEFORE CONTACTING TECHNICAL SUPPORT.

PROBLEM	REASON	SOLUTION
Noisy	Water tank or filter fitted incorrectly Dehumidifier on uneven surface	Check and refit the water tank or filter Check dehumidifier is on an even level surface
	There is sound created when air is passing through the dehumidifier.	This is normal
Frost Appears on Coils	Dehumidifier has been recently turned on, or room temperature is below 15°C	This is normal. Frost will usually disappear within 60 minutes. Do not operate the dehumidifier in tempera-

In the unlikely event of a problem with your product, please refer in the first instance to:

**ECOAIR TECHNICAL SUPPORT** : [www.ecoair.org/support](http://www.ecoair.org/support)  
**PRODUCT MANUAL GO TO** : [ecoair.org/pages/help-and-support](http://ecoair.org/pages/help-and-support)